

The Sudden Polarization Effect and Its Possible Role in Vision†

LIONEL SALEM

Laboratoire de Chimie Théorique (ERA 549), Université de Paris-Sud, 91405 Orsay Cedex, France

Received June 19, 1978

The story of the "sudden polarization" effect starts on the West Coast. In 1970, at Berkeley, Dauben and collaborators obtained¹ highly stereospecific products in the photocyclization of *trans*-3-ethylidenecyclooctene:

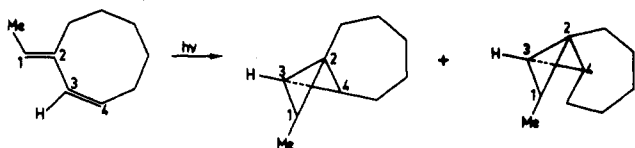

To account for the exclusively conrotatory closure of the 123 ring, Dauben made the daring proposal that an intermediate zwitterion is formed via twisting of the 34 bond:

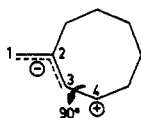

The originality of this proposal lies in the highly ionic character of the would-be intermediate formed by the neutral, nonpolar hydrocarbon. A few years later Dauben assumed a similar zwitterionic intermediate² in the stereospecific³ photocyclization of hexatriene to bicyclo[3.1.0]hexene:

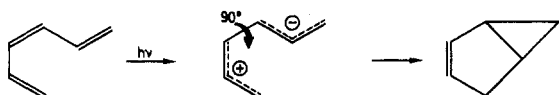

Very soon after these mechanistic postulates, and independently, Wulfman and Kumei published a short thought-provoking note⁴ in which they first reminded the reader that the two lowest excited singlet states of twisted ethylene are ionic⁵ (albeit nonpolar):

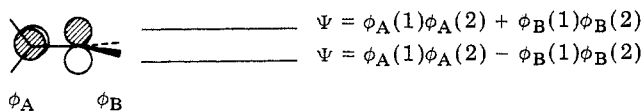

Furthermore, since the energy separation between the two states is very small (~ 0.2 eV), under an appropriate perturbation one state can easily borrow specific ionic character (A^+B^+ or B^-A^+) from the other state. Wulfman and Kumei suggested that a local external electric field near either end of the twisted bond—due to a neighboring group—might thus make these states dipolar.

Lionel Salem was born in 1937. He pursued his undergraduate studies at the Sorbonne where he received his Licence. He continued his studies in Cambridge, England, with H. C. Longuet-Higgins, where he received his Ph.D. in 1960. He then left for Cambridge, Mass., where he did postdoctoral work with E. B. Wilson and where he remained on the Harvard faculty until 1963 when he returned to his native France. He is presently a CNRS Research Professor at the Université de Paris-Sud, Orsay, France. His field of research is in theoretical chemistry.

s-cis,s-trans-Hexatriene

In early 1975 we attempted a direct ab initio calculation of the two diradical states and two zwitterionic states⁶ of *s-cis,s-trans*-hexatriene twisted to 90° around its central double bond. The calculation uses the simple all-electron, self-consistent field, restricted open-shell method—a method which has been well documented⁷ and successful in potential-energy searches for various diradicals.⁸ The energy of a single all-electron determinant representing the open-shell configuration ab (a and b, nonbonding orbitals of the two radical sites) is calculated. The energies of the open-shell singlet state ¹ab and two closed-shell singlets ¹a², ¹b² are then evaluated by appropriate corrective formulas and a three-by-three configuration-interaction procedure. In rare cases of molecules with extremely high symmetry, this limited configuration-interaction procedure may be deficient;⁹ there is no such high symmetry here. A minimal STO-3G basis set of Gaussian orbitals and the Gaussian 70 program¹⁰ were used for the SCF procedure.

To our great surprise, the very first calculation on hexatriene yielded (for the lowest zwitterionic state Z₁) a highly unbalanced charge distribution

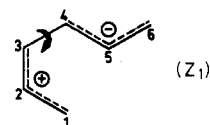

instead of the uniform distribution expected from the resonance scheme:¹¹

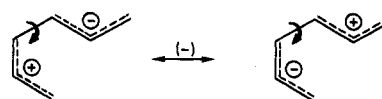

In I, roughly 0.8 net electron is found in the *s-trans*

† Dedicated to Professor E. Havinga on the occasion of his 70th birthday.
 (1) W. G. Dauben and J. S. Ritscher, *J. Am. Chem. Soc.*, **92**, 2925 (1970).
 (2) W. G. Dauben, M. S. Kellog, J. I. Seeman, N. D. Wietmeyer, and P. H. Wendschuh, *Pure Appl. Chem.*, **33**, 197 (1973).
 (3) A. Padwa, L. Brodsky, and S. Clough, *J. Am. Chem. Soc.*, **91**, 6767 (1972).
 (4) C. E. Wulfman and S. E. Kumei, *Science*, **172**, 1061 (1971).
 (5) R. S. Mulliken, *Phys. Rev.*, **41**, 751 (1932).
 (6) L. Salem and C. Rowland, *Angew. Chem., Int. Ed. Engl.*, **11**, 92 (1972).
 (7) L. Salem, C. Leforestier, G. Segal, and R. Wetmore, *J. Am. Chem. Soc.*, **97**, 479 (1975). See in particular eq 9.
 (8) L. Salem in "The New World of Quantum Chemistry", B. Pullman and R. Parr, Ed., D. Reidel, Publishers, Dordrecht, p 241.
 (9) For the case of D_{3h} trimethylenemethane see W. T. Borden, *J. Am. Chem. Soc.*, **97**, 2906 (1975); D. A. Dixon, R. Forster, T. A. Halgren, and W. Lipscomb, *ibid.*, **100**, 1959 (1978).
 (10) W. J. Hehre, W. A. Lathan, R. Ditchfield, M. D. Newton, and J. A. Pople, Program No. 236, Quantum Chemistry Program Exchange, University of Indiana, Bloomington, IN.
 (11) The minus sign indicates out-of-phase resonance.

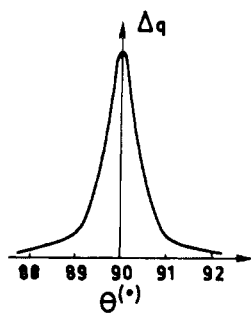
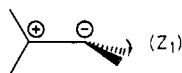

Figure 1. Charge separation as a function of twist angle in the lowest excited state of *s-cis,s-trans*-hexatriene twisted around its central bond. The curve is not symmetric about 90°.

fragment, with an identical net hole in the *s-cis* portion. Such a charge separation, in a nonpolar neutral hydrocarbon, is enormous by conventional standards. Our excitement was compounded by the agreement between I and Dauben's earlier postulated intermediate.

To investigate the nature of this unexpected phenomenon, we first varied the twist angle around the central 34 bond. Although the charge separation peaks very sharply at 90° (Figure 1), it remains significant over a 2° "window" surrounding this angle.¹² The sharp and sudden nature of the polarization peak incited us to label the phenomenon "sudden polarization effect".

The rapid drop to zero at twist angles away from 90° indicates that incipient overlap between the two allylic fragments rapidly destroys this polarization. Small overlap between radical fragments must therefore be a prerequisite for the effect to occur. A second calculation¹² on the smallest possible dissymmetric system, a 90°-twisted ethylene with one pyramidalized methylene group



II

showed that a slight dissymmetry is also a prerequisite for polarization. In II, for a pyramidalization angle as small as 10°, there is already an 0.5e charge separation! As an additional check, calculations on *s-cis,s-cis*-hexatriene and *s-trans,s-trans*-hexatriene were verified to give no charge separation whatsoever.

In a third stage geometry optimizations were carried out¹³ on both polarized zwitterionic states Z_1 and Z_2 . Indeed, if Z_1 is polarized as in I, Z_2 adopts the opposite polarization. Separate optimization of both polarized forms in 90°-twisted butadiene

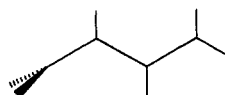

yields a double minimum potential for the lowest singly excited state (Figure 2). In Michl's language,¹⁴ there are two distinct "funnels" which should provide distinct photochemical pathways.

(12) V. Bonacic-Koutecky, P. Bruckmann, P. Hiberty, J. Koutecky, C. Leforestier, and L. Salem, *Angew. Chem., Int. Ed. Engl.*, **14**, 575 (1975). Dr. W. D. Stohrer also participated in the early discussions on the sudden polarization effect.

(13) P. Bruckmann and L. Salem, *J. Am. Chem. Soc.*, **98**, 5037 (1976).

(14) J. Michl, *J. Mol. Photochem.*, **4**, 243 (1972).

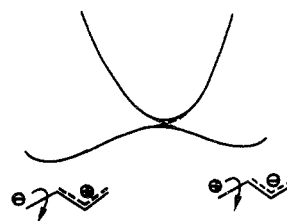
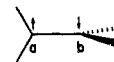

Figure 2. Excited singlet states of methyleneallyl (the twist angle is fixed at 90°).

A Simple Theoretical Picture

The occurrence of a large intramolecular charge separation is less surprising when it is realized that the zwitterionic states lie some 140 kcal/mol (80 between Z and ground-state D^{15} and 60 between twisted D and planar polyene) above the ground state of the polyene in its equilibrium geometry.

Further understanding is provided in the following manner. Consider as starting point the ground-state, albeit high-energy, twisted diradical.



We now excite this diradical. There are only two ways to do this: (1) via a local ($2p \rightarrow 3s$, etc.) excitation on sites a or b—such Rydberg states, which probably do exist in the vicinity of Z , will not be considered further; (2) barring this, via transfer of one electron from either site to the other, to create the observed intramolecular ion pair. If the two sites are *rigorously* symmetry equivalent, the negative charge cannot choose between them. Classically, one can think of it as "fluctuating" back and forth, in a manner described appropriately by Pauling resonance:

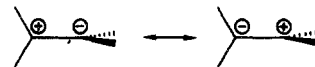

However the charge does not "migrate" that easily. Since the overlap integral between orbitals ϕ_A and ϕ_B is zero, the charge can "go back and forth" only via the exchange integral K_{ab} . The frequency with which the charge "moves" from left to right is¹⁶

$$\nu_0 = \frac{2K_{ab}}{\pi} = \frac{2 \times 0.0021}{\pi} \text{ au}$$

After a time $\pi/(2K_{ab}) = 1.7 \times 10^{-14}$ s the charge and the hole have interchanged their positions (at time π/K_{ab} they are back in their original positions).

Now, if for some reason one site is slightly stabilized relative to the other, by the quantity $\Delta E > K_{ab}$, the negative charge will *localize* on this more stable site. Because K_{ab} is so small ($\sim 1-2$ kcal/mol) the energy difference between sites need only be of the order of 3 kcal/mol for full localization to occur. This is readily seen by diagonalizing the secular determinant for the two-orbital system. Hence the slightest dissymmetry will be effective in polarizing the system. We can think of the polarized situation as being the "natural" one, obviated only in systems of the highest symmetry. The amount of charge transferred back and forth decreases from 1 to

(15) R. J. Buenker and S. D. Peyerimhoff, *Chem. Phys.*, **9**, 75 (1975).

(16) H. A. Bethe and E. E. Salpeter, "Quantum Mechanics of One and Two-electron Systems", Springer-Verlag, Berlin, 1957, p 132.

$$\Delta q = 4 \frac{K_{ab}^2}{\Delta E^2} \quad (\Delta E > 2K_{ab})$$

(the electronegative center keeping permanently $(1-4K_{ab}^2/\Delta E^2)$ negative charge). However the frequency of exchange increases from $2K_{ab}/\pi$ to¹⁷

$$\nu = \Delta E/\pi > \nu_0 \quad (\Delta E > 2K_{ab})$$

At the extreme limit of very large ΔE , the system would tend toward a permanent dipole with full unit charge separation and infinitesimal charge exchange at infinite frequency.

If on the other hand we introduce some true orbital overlap between ϕ_A and ϕ_B , exchange of charge becomes more facile and little or no polarization will occur.

Not a Theoretical Artifact

In view of the extremely surprising characteristics of the sudden polarization effect, it was imperative that, until a definitive experimental verification is carried out, thorough theoretical calculations be executed to establish that no artifact is involved. Numerous groups have carried out such theoretical calculations which, without exception, confirm the phenomenon.

(1) First of all, Malrieu and collaborators showed¹⁸ that the effect is not specific to the use of delocalized molecular orbitals, but occurs in a localized orbital model (the CIPSI PCIL0 technique). They did show, however, that the size of the dipole is smaller than that obtained in the limited three-by-three configuration-interaction calculation. Indeed charge tends to concentrate near the twisted double bond. Thus the overall dipole will be roughly independent of the size of the system and of the order of 4 debyes.

(2) Mulder on one hand¹⁹ and Karplus on the other²⁰ have shown that the effect is not specific to the molecular orbital technique itself. A full orthogonal *valence-bond* treatment of the π electrons yields sudden polarization in twisted *s-cis,s-trans*-hexatriene, with, however, a curious change of sign at the 90° twist angle.

(3) Returning to the molecular approach, one might inquire whether the limited nature of the basis set does not provide a bias to the calculation. However, the use of extended (4-31G)¹⁰ basis sets confirms the polarized nature of the zwitterionic states, even though sometimes the sign of the polarization is reversed relative to the limited basis set calculations.

(4) Since the possibility had been raised²¹ that the nearly discontinuous nature of the polarization might reflect a discontinuous energy solution typical of certain Hartree-Fock "instabilities", it was necessary to carry out a calculation beyond the Hartree-Fock limit. This has now been done by Schaefer and collaborators,²²

(17) The problem treated here is analogous to that of two coupled oscillators which are slightly out of tune. As shown by A. Sommerfeld, "Mechanics" (Vol. I, Academic Press, New York, 1964, p 106), the imperfect tuning leads to an incomplete transfer of energy—here an incomplete transfer of charge. See also eq 41-10 of L. Pauling and E. B. Wilson, "Introduction to Quantum Mechanics" (McGraw-Hill, New York, 1937), for the appropriate starting differential equations.

(18) M. C. Bruni, J. P. Daudey, J. Langlet, J. P. Malrieu, and F. Momicchioli, *J. Am. Chem. Soc.*, **99**, 3587 (1977).

(19) C. M. Meerman van Benthram, H. J. C. Jacobs, and J. J. C. Mulder, *Nouv. J. Chim.*, **2**, 123 (1978).

(20) M. Karplus and I. Ohmine, unpublished results.

(21) G. Berthier, private communication to the author (1977). Recently G. Berthier, B. Levy, and L. Praud, *Gazz. Chim. Ital.*, **108**, 377 (1978), have shown that the size of the polarization depends on the symmetry constraints applied to the molecular orbitals of the SCF treatment.

(22) P. R. Brooks and H. F. Schaefer, *J. Am. Chem. Soc.*, in press.

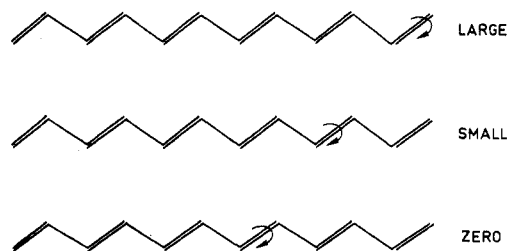

Figure 3. Polarization in the lowest excited singlet state of *all-trans*-hexadodecaenes.

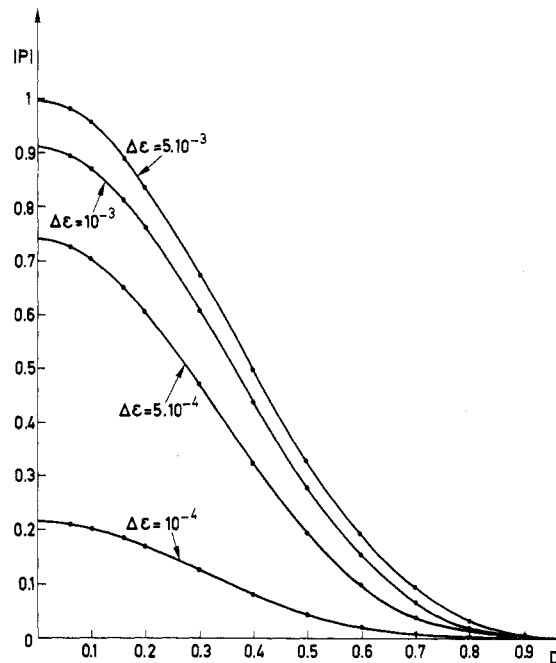

Figure 4. Net polarization ($P = (q_A - q_B)/2$) as a function of delocalization, D .^{24b}

whose multiconfigurational self-consistent field (MCSCF) calculations confirm unambiguously the large dipole in the excited states of pyramidalized twisted ethylene. The polarization dipole is smaller in the "in-phase" or (+) Z state than in the "out-of-phase" or (-) Z state, due to the partially covalent nature of the former state demonstrated by Michl.²³ But in all cases the polarization is significant (>2.7 debyes for a small 10° pyramidalization). This is particularly true for his full 12-electron CI calculation even though in his constrained SCF calculation, Schaefer takes care to keep the weights of the starting configurations $^1a^2$ and $^1b^2$ equal at all geometries.

Understanding the Extent of Polarization

In certain 90°-twisted polyenes the calculated polarization is negligible²⁴ in spite of the dissymmetry between the two radical sites. This is illustrated by the series of 90°-twisted *all-trans*-dodecahexenes, where the polarization is as indicated in Figure 3. To understand the trend in the polarization, Hiberty and Karafiloglou in our laboratory addressed the general problem of the charge distribution in the three singlets 1D , Z_1 , and Z_2 as a function of delocalization (measured as a parameter $0 < D < 1$ representing the ratio of the amplitudes of the highest orbital on the two fragments) of the non-

(23) J. Michl, *Pure Appl. Chem.*, **41**, 507 (1975).

(24) (a) Unpublished calculations by V. Bonacic-Koutecky (Berlin); (b) P. Hiberty and P. Karafiloglou, *Chem. Phys. Lett.*, to be submitted.

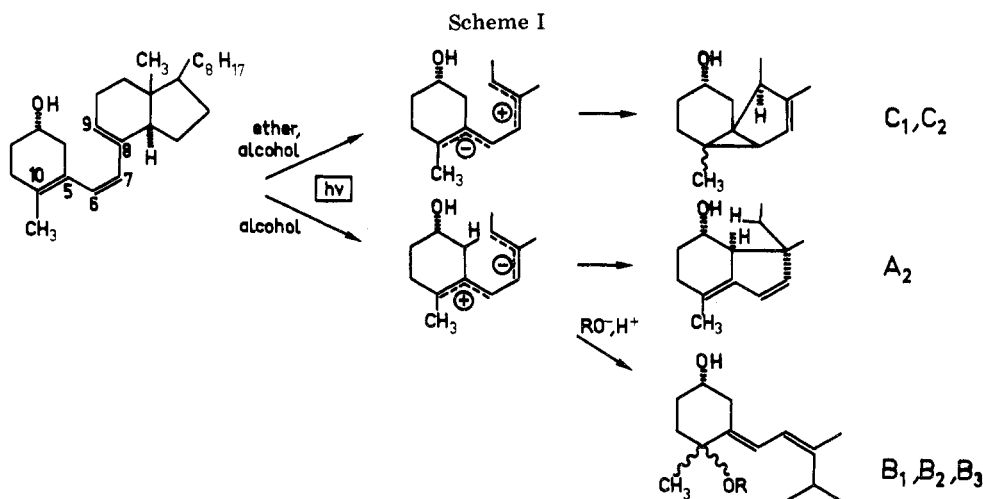

bonding orbitals *a* and *b* between the two radical sites. The results are shown as polarization vs. *D* curves in Figure 4. Each curve is obtained for a different value of the energy difference $\Delta\epsilon$ between orbitals *a* and *b*—a rough measure of the differential stability between the two sites.

The curves of Figure 4 are readily interpreted. For $D = 0$ (vertical axis) orbitals *a* and *b* are strictly localized on their respective sites, implying zero overlap between the two fragments. For $\Delta\epsilon$ sufficiently large (and *D* still 0), one site is sufficiently stable relative to the other to attract the negative charge; a large polarization occurs. This corresponds to the terminally twisted molecule in Figure 3, for which the odd methylenic orbital is rigorously orthogonal to the odd orbital of the remaining 11-atom chain. If some overlap exists between the two fragments, *D* increases (horizontal axis), the more so the less dissymmetric the fragments. Since exchange between the two sites is easier, the polarization drops rapidly (second molecule in Figure 3). In the nearly symmetric system (third molecule, Figure 3) it has practically vanished.

Understanding the Sign of the Polarization

A solution to this difficult problem has been provided by Koutecky and collaborators²⁵ for *s-cis,s-trans*-hexatriene. They assume the two terminal atoms to be slightly less electronegative than the four central ones, to which slightly negative Coulomb integrals are attributed:

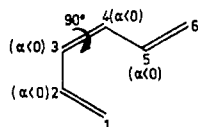

They then "create" the excited Z state by appropriate excitation from the ground diradical state. The excitation energy includes a repulsion integral with a negative sign: $-\gamma_{\text{initial site, final site}}$, which represents the relief of the electronic repulsion which existed between electrons in the starting diradical. Keeping only charge transfers which terminate at the "electronegative" atoms 2, 3, 4, or 5 (and remembering that atoms 2 and 5 carry zero net charge in the zwitterions), Koutecky et al.²⁵ show that the excitation energies of the two

oppositely polarized forms are differentiated by the two terms

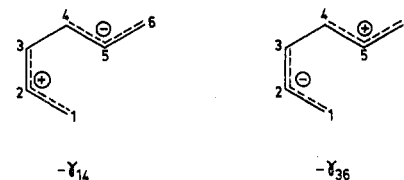

Since $\gamma_{14} > \gamma_{36}$ (indeed $R_{14} < R_{36}$), the polarized form on the left-hand side has the lower energy and will predominate in the lower zwitterionic state.

Other Polarized Excited Intermediates

Calculations on typical unsymmetrical diradical intermediates yield highly polarized excited states. This is the case for edge-to-face trimethylene (III) or cyclopropylbiscarbinyl (IV) in a bisected, eclipsed conformation. It is tempting to ascribe the observed

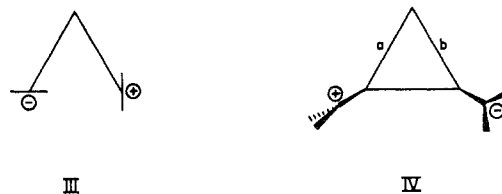

substituent effects on the outcome of the di- π -methane rearrangement²⁶—preferred rupture (a) opposite to the more electron-accepting substituent—to the excited, suddenly polarized zwitterion IV.

The pioneering experiments of Havinga and his collaborators²⁷ on the photochemistry of vitamin D have recently been reinterpreted¹⁹ in terms of two oppositely polarized *s-cis,s-trans* diallylic fragments after 90° twist around the 67 bond of the hexatriene fragment (Scheme I). The six product toxisterols are thus incorporated into a single scheme. Still, there remains to explain why different solvents promote different dipolar forms.

Sudden Polarization in the Visual Chromophore

A rough description of a rod cell of the eye is shown in Figure 5. The essential characteristic is the flow of

(26) D. W. Alexander, A. C. Pratt, D. M. Rowley, and A. E. Tipping, *J. Chem. Soc., Chem. Commun.*, 101 (1978).

(27) (a) F. Boomsma, H. J. C. Jacobs, E. Havinga, and A. van der Gen, *Recl. Trav. Chim. Pays-Bas*, 96, 104 (1977); (b) H. J. C. Jacobs, F. Boomsma, E. Havinga, and A. van der Gen, *ibid.*, 96, 113 (1977), and references therein; (c) H. J. C. Jacobs and E. Havinga, *Advan. Photochem.*, in press.

(25) V. Bonacic-Koutecky, J. Cizek, D. Dohnert, and J. Koutecky, *J. Chem. Phys.*, 69, 1168 (1978).

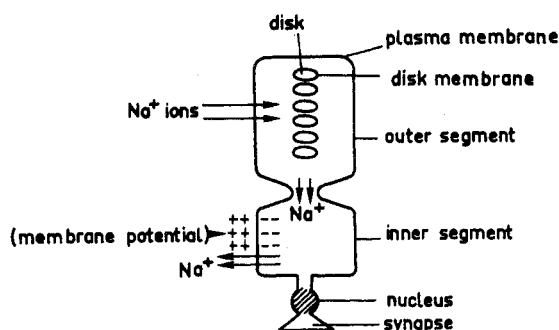

Figure 5. Schematic description of rod cell.

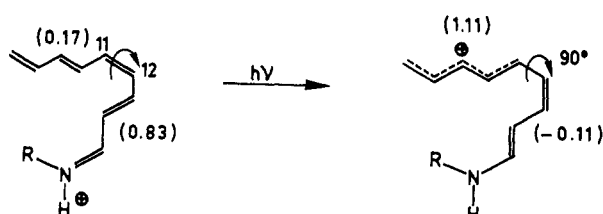
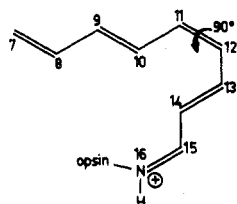

Figure 6. Sudden polarization in the *N*-retinylidene chromophore, after excitation and twist. The calculated charges correspond to $R = \text{CH}_3$.

sodium ions from outer segment to inner segment. When light impinges on the cell the plasma membrane becomes less permeable to the ions. Apparently, this arises from a change in the membrane potential, itself triggered by a change in permeability of the disk membranes. These disk membranes contain rhodopsin, which is the crucial molecule for vision.

The rhodopsin molecule appears to be a protonated Schiff base of retinal²⁸ (for an opposing viewpoint see ref 29) attached to opsin, a protein moiety. The essential part of the chromophoric skeleton is the opsin-linked nonatetraenylideneiminium ion.



Primary excitation of rhodopsin leads to a new species, prelumirhodopsin, via what has long been described as isomerization around the 11,12 bond from the 11-cis to the all-trans form³⁰ of retinal. The primary process, whatever its nature, has been shown to occur in less than 6 s.³¹

Rotation of the conjugated skeleton by only 90° around C₁₁-C₁₂ would lead to two different pentadienyl fragments. Sudden polarization would then occur in the lowest singlet excited state of the twisted chromophore, and we have suggested³² that this polarization is the crucial, primary event in the overall mechanism leading to vision. Figure 6 shows the

(28) A. R. Oseroff and R. H. Callender, *Biochemistry*, **13**, 4243 (1974).

(29) (a) J. Shriver, G. Mateescu, R. Fager, D. Torchia, and E. W. Abrahamson, *Nature (London)*, **270**, 271 (1977); (b) J. Favrot, J. M. Leclerc, R. Roberge, C. Sandorfy, and D. Vocelle, *Chem. Phys. Lett.*, **53**, 433 (1978).

(30) (a) G. Wald, *Nature (London)*, **219**, 800 (1968); (b) J. B. Hurley, T. G. Ebrey, B. Honig, and M. Ottolenghi, *ibid.*, **270**, 540 (1977).

(31) G. E. Busch, M. L. Applebury, A. A. Lamola, and P. M. Rentzepis, *Proc. Natl. Acad. Sci. U.S.A.*, **69**, 2802 (1972).

(32) (a) L. Salem and P. Bruckmann, *Nature (London)*, **258**, 526 (1975); (b) L. Salem, *Science*, **191**, 822 (1976).

outcome of sudden polarization in the twisted retinoid skeleton. As usual, a pair of opposite net charges is created. Here the negative charge simply cancels the pre-existing positive charge on the imino group. The positive charge localizes on the 7-11 fragment, in particular on atoms 7, 9, and 11 (it is noticeable that atom 9 carries a methyl substituent, which can stabilize this charge). Therefore the positive charge, which was initially on one end of the molecule, swooshes down to the other end! Light has triggered an electrical signal, with a change in dipole moment of the order of 40 debyes.^{32,33} It is tempting to assume that this electrical signal in turn triggers a change in ion permeability of the disk membrane. Although rotation by 90° is consistent with a 6-ps primary process,³² our proposed mechanism is presently purely speculative and has yet to find experimental support.

Several groups have recently used this assumed sudden polarization in the visual chromophore³² as the starting point of detailed theories of the primary event in vision.

(1) Aaron Lewis has suggested³⁴ that the charge redistribution in the excited chromophore induces bond rearrangement in the protein structure. As the protein deforms to stabilize the excited-state distribution, it concomitantly destabilizes the ground-state distribution and a surface crossing occurs.³⁵ The "batho" or "prelumi" rhodopsin intermediate is then reached as the chromophore further relaxes. Although Lewis does not require that the excited chromophore be twisted, it is apparent^{30b,32} that the largest redistribution, and lowest energy—hence the surface crossing—are most likely to occur for the 11-12 90° twisted conformation.

(2) By their picosecond studies on deuterated rhodopsin and bacteriorhodopsin, Peters, Applebury, and Rentzepis have shown³⁶ that the production of prelumirhodopsin, and of prelumibacteriorhodopsin, are processes whose rate-limiting step involve proton translocation. Although they raise some doubt as to actual cis-trans isomerization in the overall process (but see ref 30b), they suggest that proton translocation toward the Schiff base nitrogen—highly basic in the 11-12 90°-twisted suddenly polarized form³²—is a possible mechanism.^{29b,36}

(3) Kosower has suggested³⁷ that a carboxyl counterion near the protonated Schiff base rotates after the positive charge leaves the nitrogen atom in the polarized 11-12 90°-twisted form. This rotation would then induce specific, permanent changes.

(4) Mathies has suggested³⁸ that a proton is pulled off C₉ in the twisted polarized state. This proton could then, eventually, return to the carbon atom. The assumed C₉ locus (rather than N₁₆) for proton translocation would be justified by the permanence of the C=N stretching frequency in prelumirhodopsin.³⁸

(33) There is evidence that, in the vertically excited state of retinylidene chromophore at least, there is a large dipole moment: R. Mathies and L. Stryer, *Proc. Natl. Acad. Sci. U.S.A.*, **73**, 2169 (1975).

(34) A. Lewis, *Proc. Natl. Acad. Sci. U.S.A.*, **75**, 549 (1978).

(35) It has recently been suggested (A. Warshel and C. Deakyne, *Chem. Phys. Lett.*, **55**, 459 (1978)) that charge stabilization by the protein can also strongly stabilize the ground potential energy surface of the chromophore.

(36) (a) K. Peters, M. L. Applebury, and P. M. Rentzepis, *Proc. Natl. Acad. Sci. U.S.A.*, **74**, 3118 (1977); (b) M. L. Applebury, Conference at the APS Meeting, Washington, D.C., March 1978.

(37) E. M. Kosower, private communication to the author (1978).

(38) R. Mathies, private communication to the author (1978).

(5) Our own view is that the polarized intermediate would best be stabilized by negative countercharges near atoms 7, 9, and 11.³⁹ A sharp drop in energy, down to ground state, similar to that advocated by Lewis, would then occur, and the first visual intermediate would be formed.

Conclusion

The definitive experimental verification of the sudden polarization effect remains to be done. An extremely strong indication would be given by disrotatory cyclopropane ring closure in hexatrienes substituted by donor groups on the s-trans moiety. The ensuing

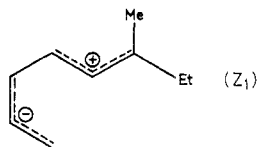

polarization should indeed be opposite to that en-

(39) Such charges would also, at least partially, account for the famous shift occurring when chromophore is linked to protein.

countered usually.⁴⁰ A more direct test would be observation of strong intensification of resonance Raman lines of the lowest excited state (as monitored by picosecond spectroscopy) in the hexatriene molecule as it twists into its highly polarizable—and highly polarized—geometry. These two experiments are now being carried out at Berkeley⁴¹ and Harvard,⁴² respectively. Another possibility would be to observe laser-excited fluorescence from twisted olefinic excited states, as presently attempted at Livermore.⁴³

This work was supported in part by a NATO grant. The author is extremely grateful to the scientists who have collaborated with him on this work, in particular Professor Jaroslav Koutecky and Drs. Vlasta Bonacic-Koutecky, Peter Bruckmann, Philippe Hiberty, Padeleimon Karafiloglou, and Claude Leforestier. Last, but not least, he thanks William Dauben whose ideas inspired this work.

(40) V. Bonacic-Koutecky, *J. Am. Chem. Soc.*, **100**, 396 (1978).

(41) W. G. Dauben, private communication to the author (1978).

(42) K. Peters, private communication to the author (1978).

(43) (a) C. Bender, private communication to the author (1978); (b) for the fluorescence of mono-olefinic hydrocarbons, see F. Hirayama and S. Lipsky, *J. Chem. Phys.*, **62**, 576 (1975).

Tobacco-Specific Nitrosamines: Occurrence, Formation, Carcinogenicity, and Metabolism

STEPHEN S. HECHT,* CHI-HONG B. CHEN, and DIETRICH HOFFMANN

Division of Environmental Carcinogenesis, Naylor Dana Institute for Disease Prevention, American Health Foundation, Valhalla, New York 10595

Received April 17, 1978

It is now widely accepted that cigarette smoking is causally associated with lung cancer.^{1,2} It is less widely known that smoking is also correlated with an increased incidence of cancer of the oral cavity, esophagus, pancreas, and bladder.²⁻⁶ Tobacco chewing can also cause oral cavity and esophageal cancer.^{3,4,7} In fact, cancer of the mouth is a major cancer among men in India, where the habit of chewing the betel quid containing tobacco is widespread.⁸ Cigarette smoke is known to contain tumor initiators, such as the polynuclear aromatic hydrocarbons, and tumor promoters and cocarcinogens, such as catechol.⁹ These agents can explain many of the observed effects of cigarette smoke condensates in experimental animals and most likely are involved in some of the human cancers associated

Dietrich Hoffmann is a member of the American Health Foundation and Chief of its Division of Environmental Carcinogenesis. He received his B.S. and M.S. degrees from the University of Kiel and the Ph.D. from the Max Planck Institute for Biochemistry, Munich, Germany. He was an Associate Member of the Sloan-Kettering Institute for Cancer Research.

Stephen S. Hecht received the Ph.D. degree from Massachusetts Institute of Technology in 1968. He is an associate member of the American Health Foundation.

Chi-hong B. Chen is a research associate at the Foundation. She earned her Ph.D. degree from New York University.

The investigators are interested in the isolation, identification, and reduction of carcinogens in materials which have been associated with human cancer, as well as in the metabolic activation of polynuclear aromatic hydrocarbons, *N*-nitrosamines, other carcinogens, and the reaction of the active species of carcinogens with cellular macromolecules. This paper is no. 17 in the series "A Study of Tobacco Carcinogenesis".

with smoking. However, nitrosamines may also be causative factors in the tobacco-related cancers, especially in those organs which are remote from direct contact with tobacco or tobacco smoke. Thus it is known that nitrosamines can cause esophageal, pancreas, and bladder cancer in experimental animals as well as affect the lung and oral cavity.¹⁰⁻¹²

Since the first report on the carcinogenicity of dimethylnitrosamine,¹³ a wide variety of nitrosamines have been tested in various experimental animals.^{10,14}

(1) U.S. Department of Health, Education and Welfare: U.S. Publ. Hlth. Serv. Publ. No. 1103, 1964; HEW Publ. No. (HSM) 71-7513, 1971; DHEW Publ. No. (CDC) 76-8704 (1975).

(2) Wynder, E. L.; Stellman, S. D. *Cancer Res.* **1977**, *37*, 4608.

(3) Wynder, E. L.; Bross, I. J.; Feldman, R. M. *Cancer* **1957**, *10*, 1300.

(4) Wynder, E. L.; Bross, I. J. *Cancer* **1961**, *14*, 389.

(5) Wynder, E. L.; Mabuchi, K.; Maruchi, N.; Fortner, J. G. *J. Natl. Cancer Inst.* **1973**, *50*, 645.

(6) Wynder, E. L.; Goldsmith, R. *Cancer* **1977**, *40*, 1246.

(7) Moore, G. E.; Bissinger, L. L.; Proehl, E. C. *J. Am. Geriatr. Soc.* **1953**, *1*, 497.

(8) Jayant, K.; Balakrishnan, V.; Sanghvi, L. D.; Jussawalla, D. *J. Brit. J. Cancer* **1977**, *35*, 232.

(9) Wynder, E. L.; Hoffmann, D. "Tobacco and Tobacco Smoke"; Academic Press: New York, 1967.

(10) Magee, P. N.; Montesano, R.; Preussmann, R. *ACS Monogr.* **1976**, *No. 173*, 491.

(11) Pour, P.; Althoff, J.; Krüger, F.; Schmähl, D.; Mohr, U. *Cancer Lett.* **1975**, *1*, 3.

(12) Pour, P.; Althoff, J.; Nagel, D. *Cancer Lett.* **1977**, *3*, 109.

(13) Magee, P. N.; Barnes, J. M. *Brit. J. Cancer* **1956**, *10*, 114.